

Article number: 390204400722736

Description: Worm Gear with Torque Limiter
VF 44-L2-A-7-P71B5

Measures

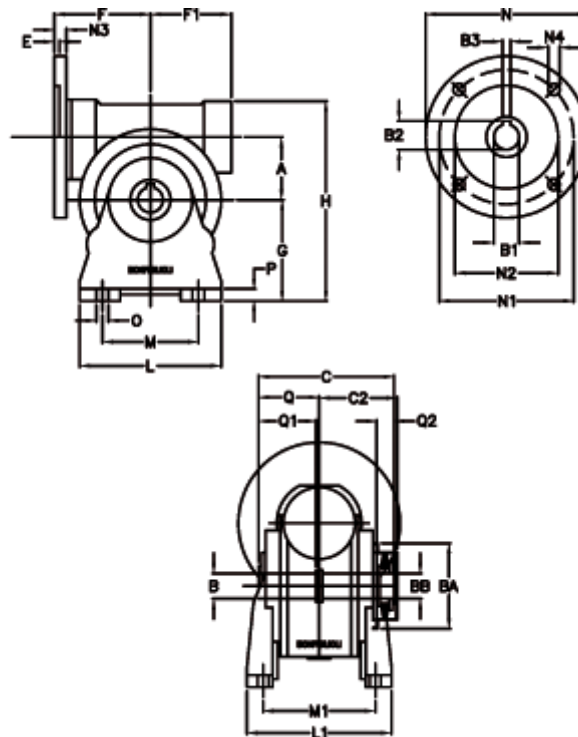

a = 44.60	C2 = 48	L1 = 98.0	O = 8.5
B = 18	Description = VF 44A-xx-71B5	m = 52	P = 10
B1 E7 = 14	E = 2.0	M1 = 81.0	Q = 32.0
B2 = 16.3	F = 65	N = 160	Q1 = 32
B3 H9 = 5	F1 = 54	N1 = 130	Q2 = 12
BA = 40	g = 72	N2 = 110	
BB H7 = 11	H = 143	N3 = 10.5	
C = 79	L = 90	N4 = 9,5	